

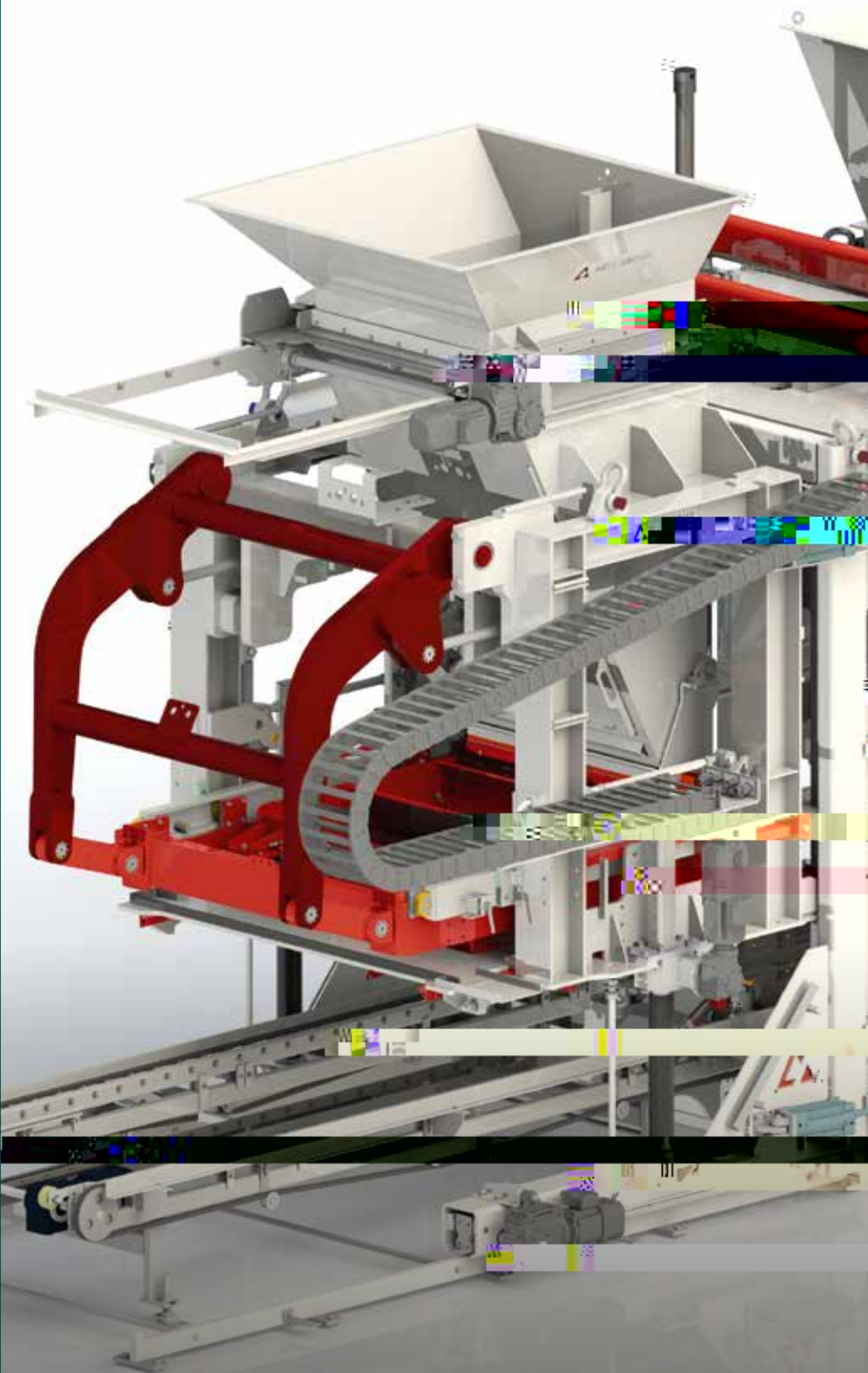

HESS GROUP

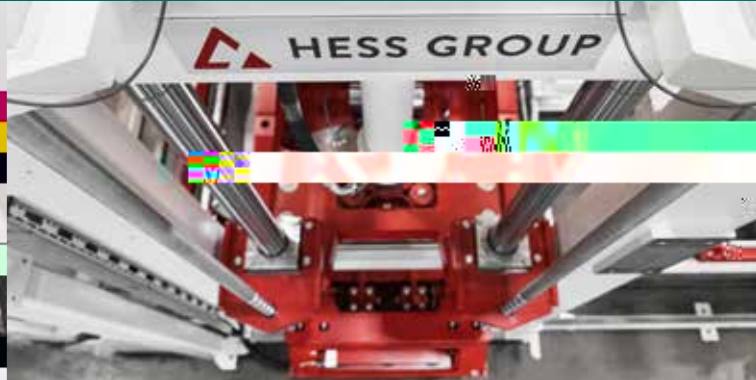

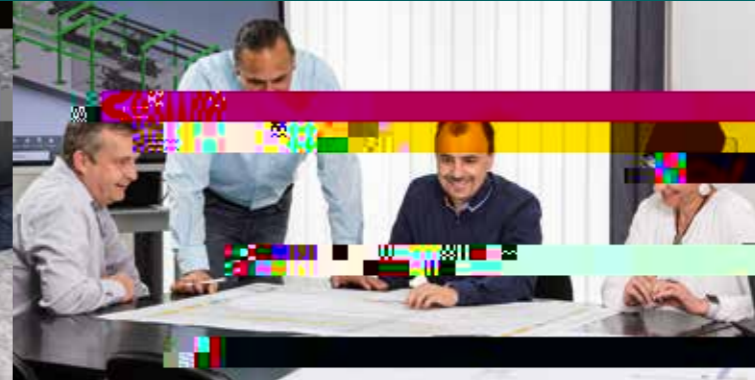

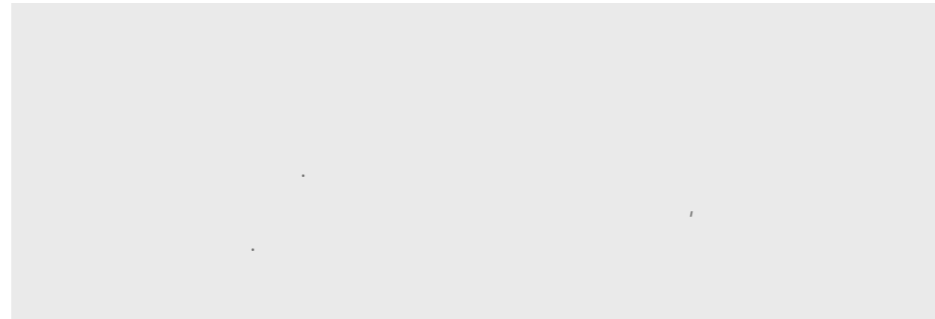
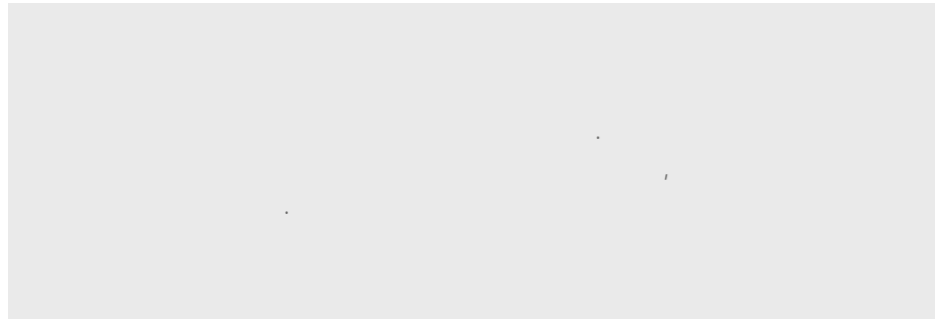
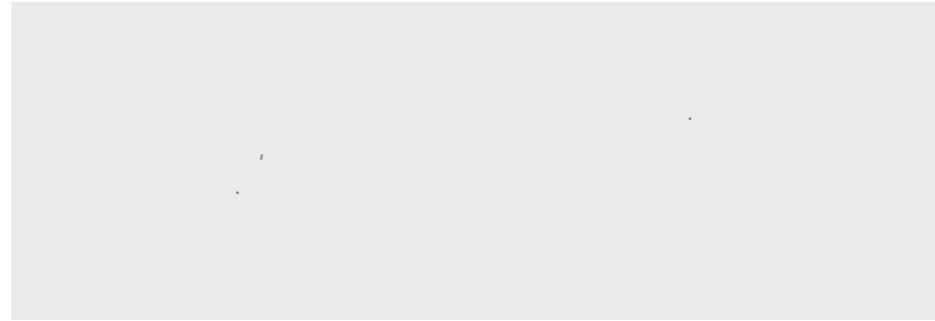
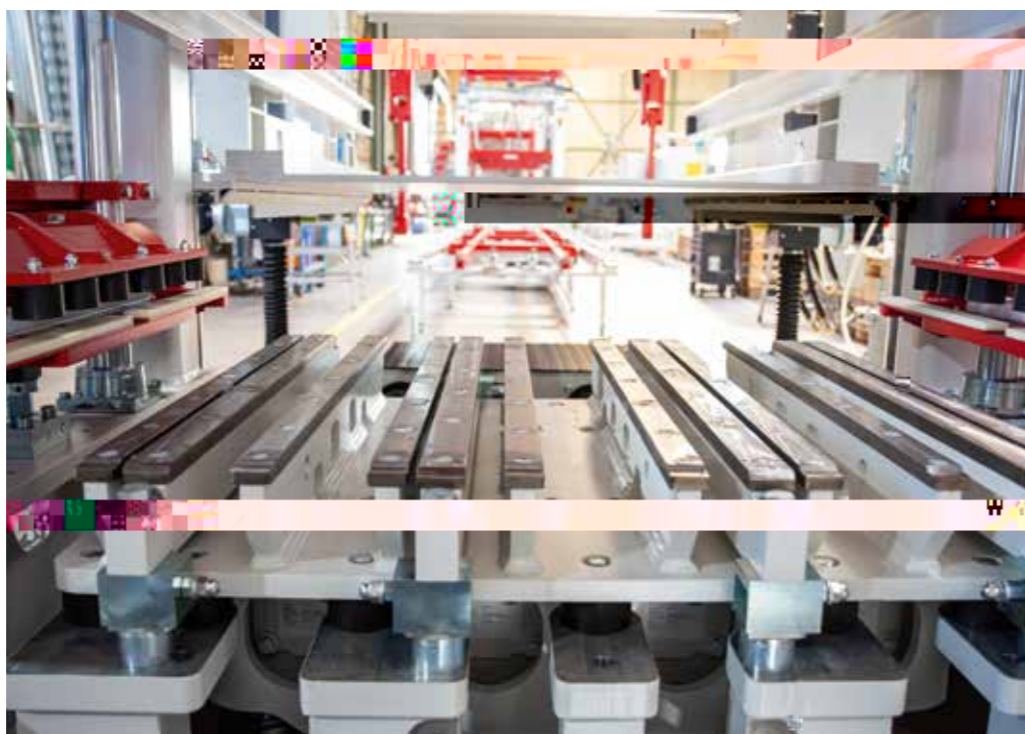
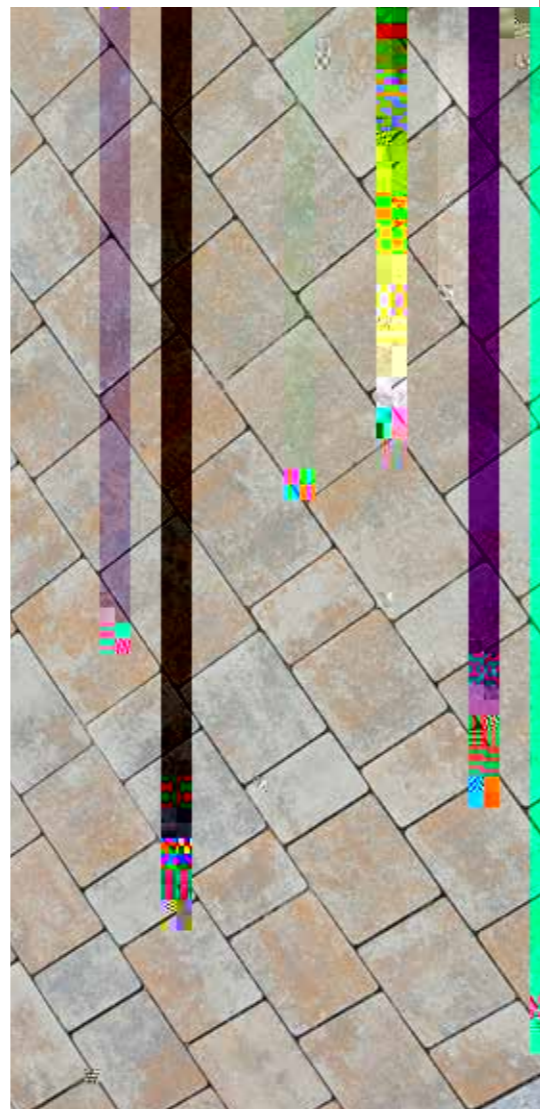
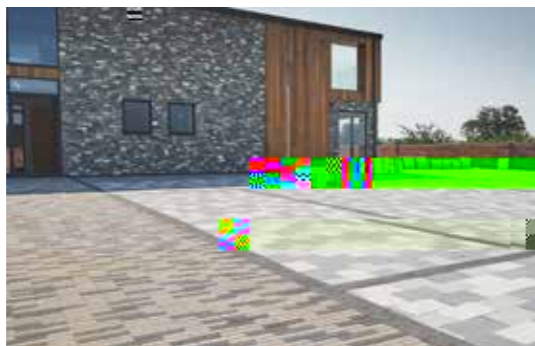

RH 1450



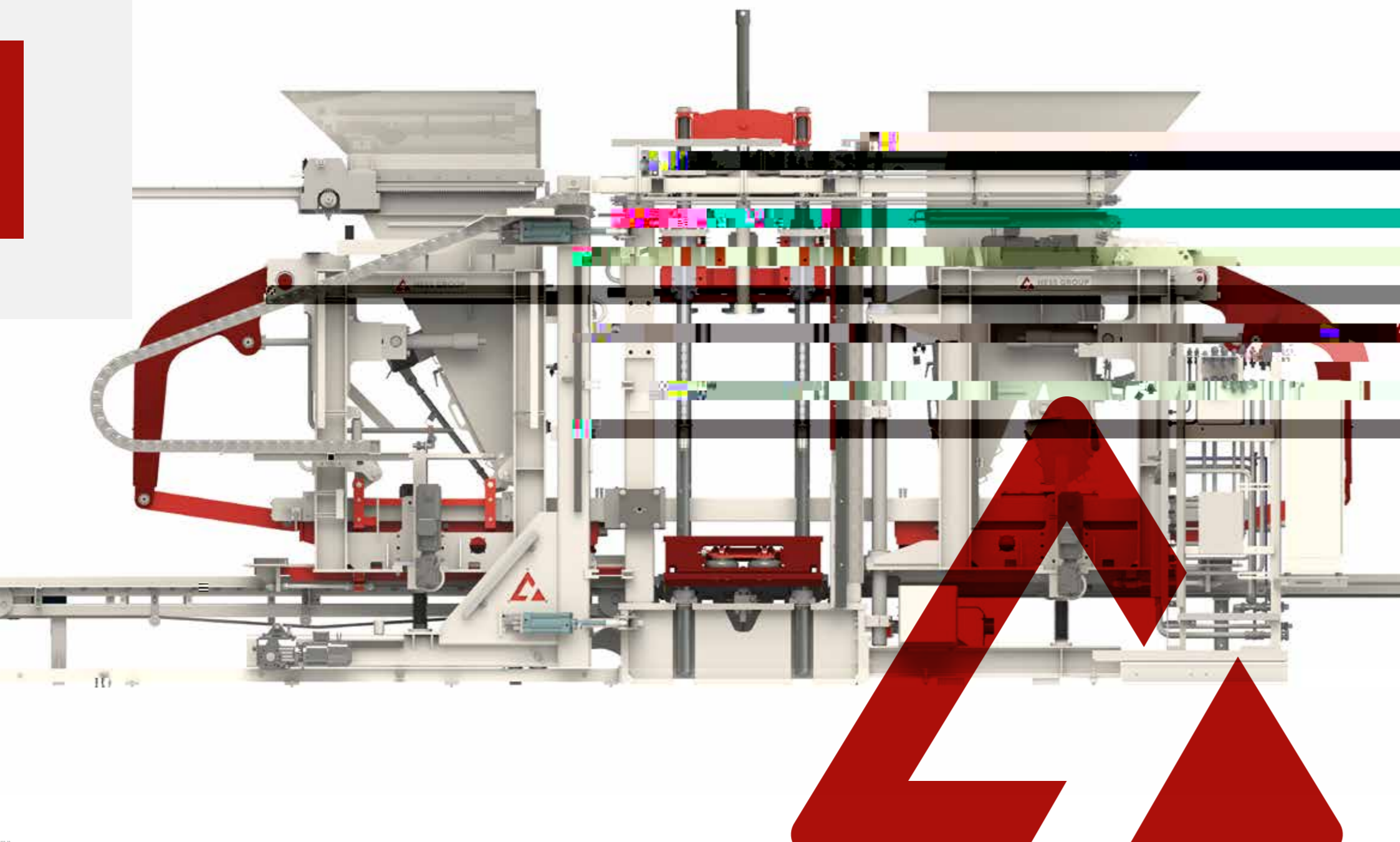

RH 1450

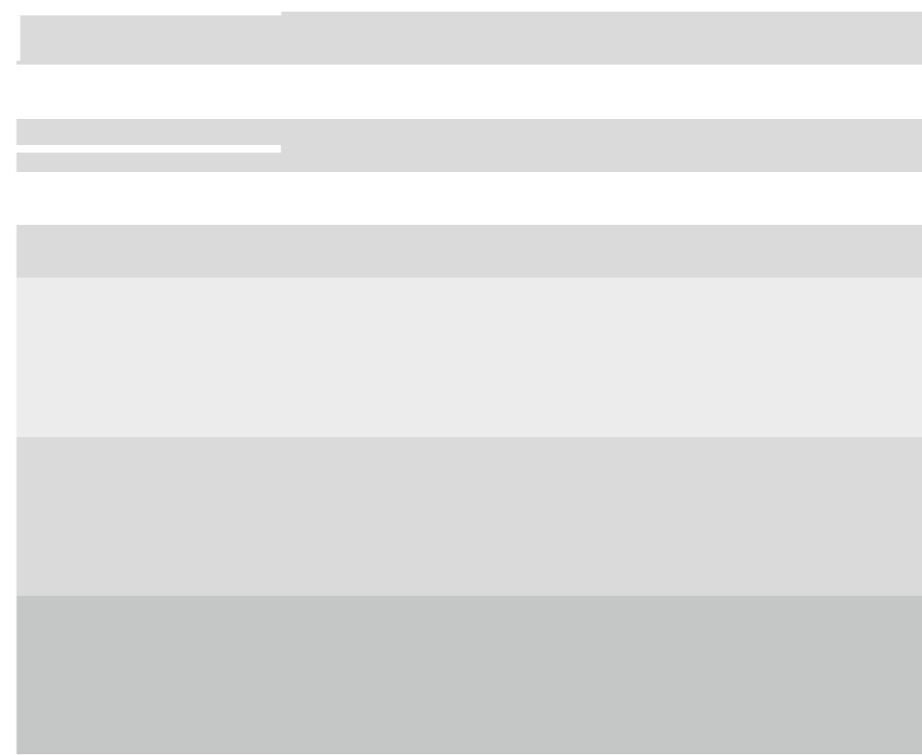

85%

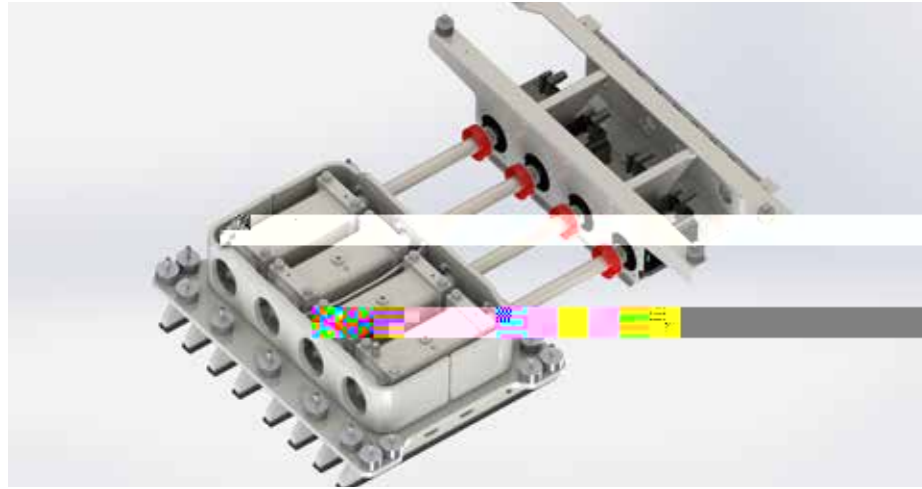
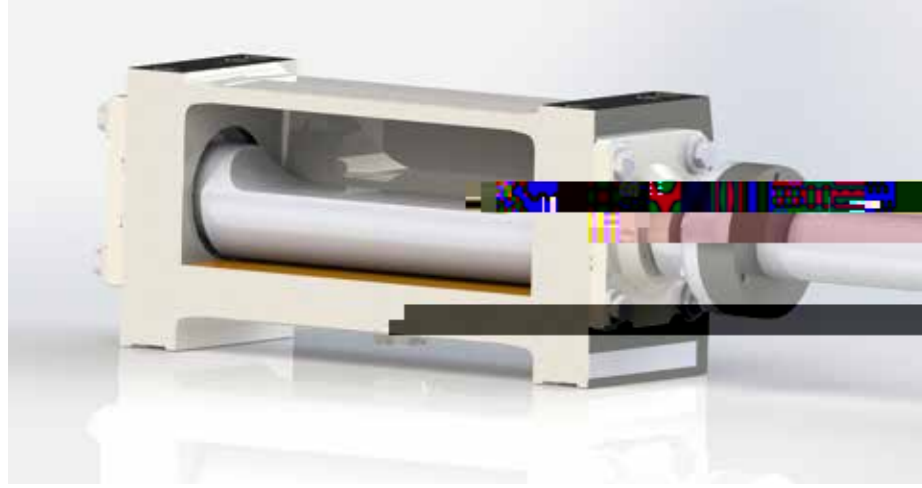

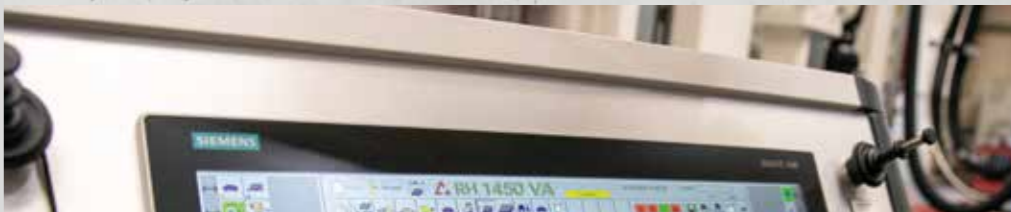

HESS



Hess

HESS

-
-
-
-

RFID-

	[]**	1.200 x 670	1.400 x 700	1.400 x 1.100	1.400 x 1.100	1.400 x 1.100	1.400 x 1.300
	[]	1.100 x 620	-	1.300 x 1.050	1.300 x 1.050	1.300 x 1.050	1.300 x 1.250
	[]	25	25	40	25	25	25
	[]	300	300	500	500	500	500
	VA []	7.700	14.000	38.000	46.000	46.000	48.000
10x20x5	[]	17	14	12,5	10,5	10	10
	² 8	863	1.258	2.114	2.517	2.644	3.230
	14	12,5	0,5	863	1.258	2,11	10,5
						5 46	3.258, 25
							M ³ 4 0,51,32 25

--	--	--	--

--	--	--	--

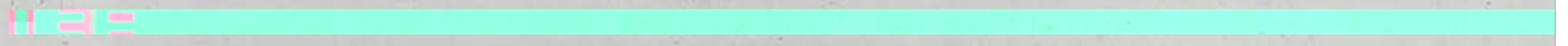
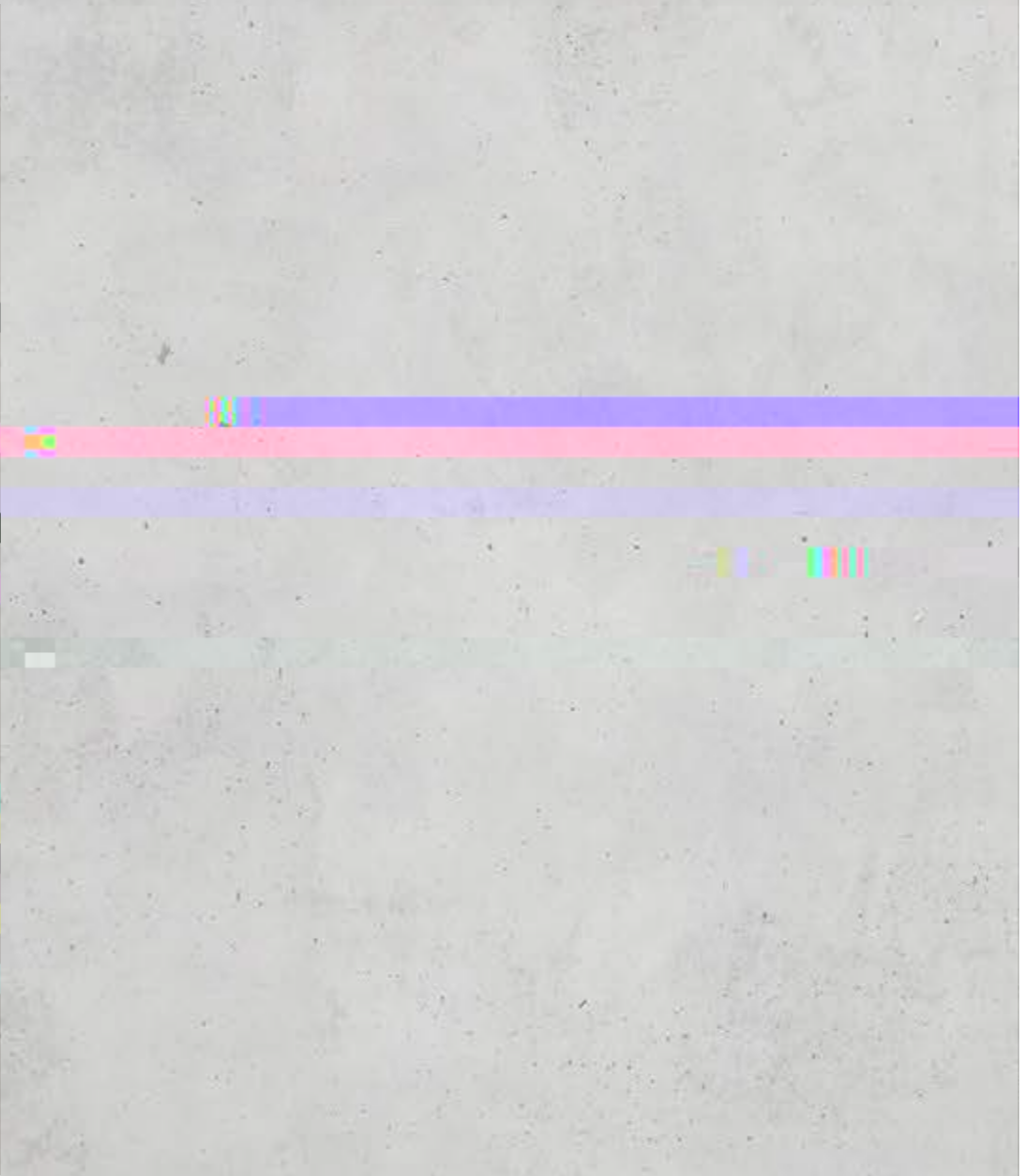
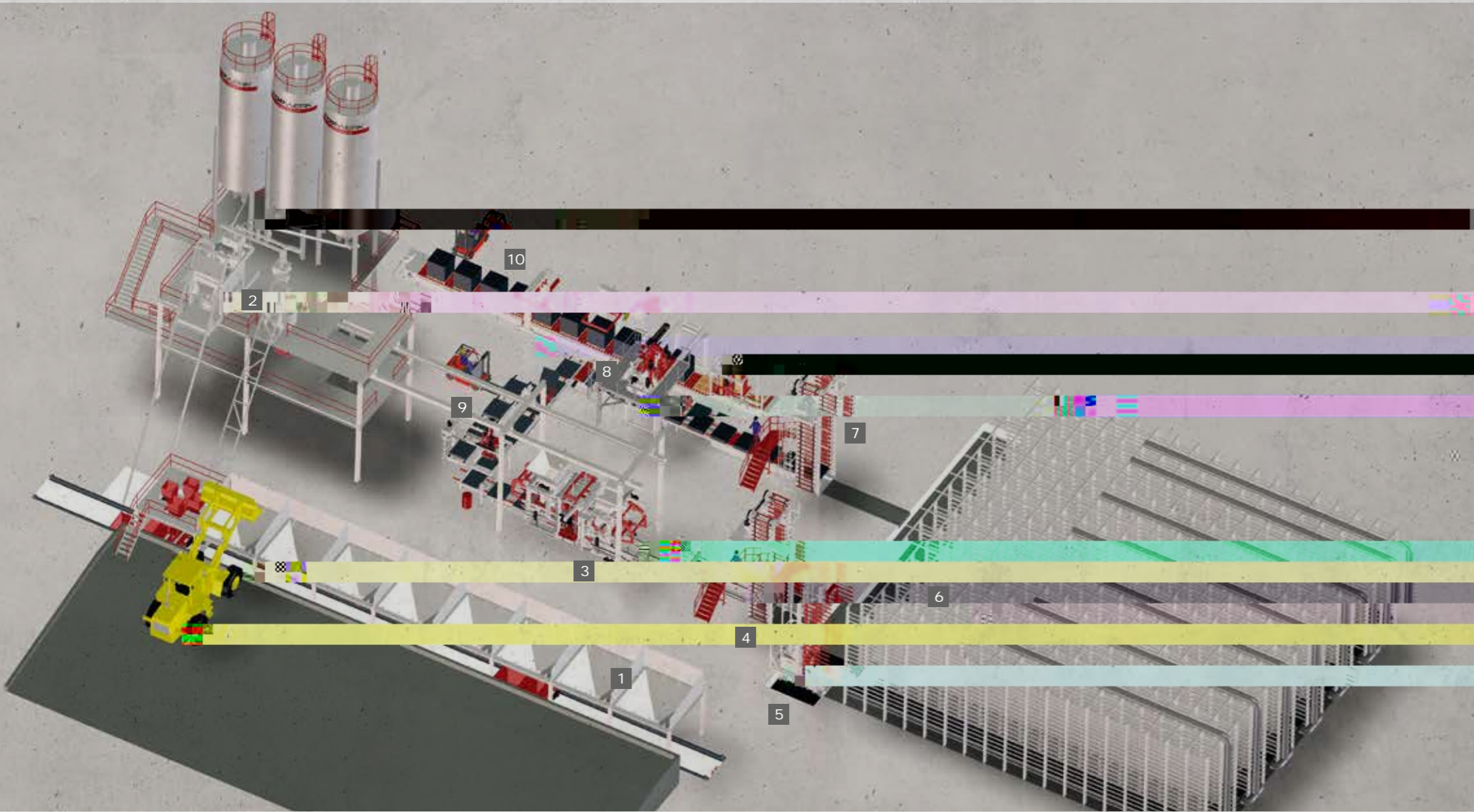

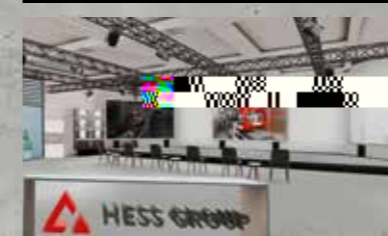
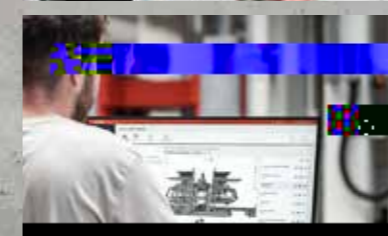
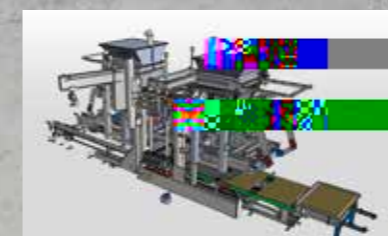
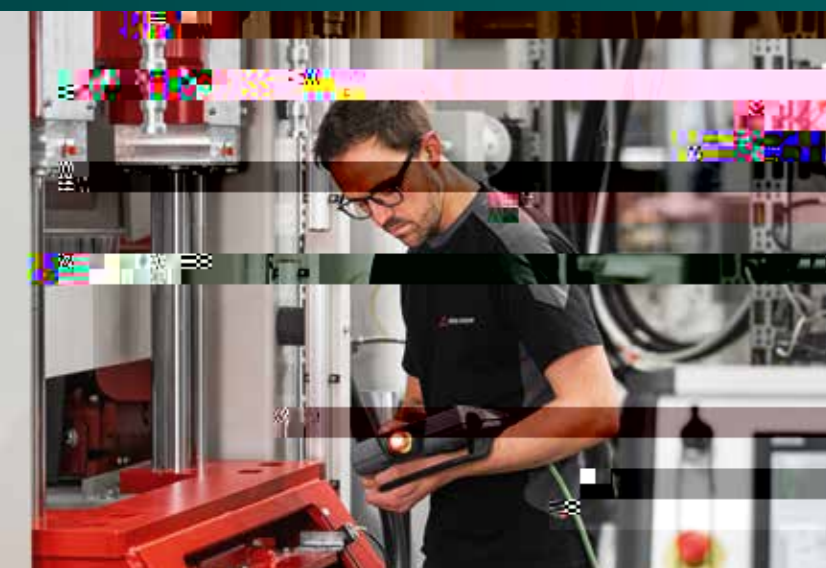



Freier-Grund-Straße 123
57299 Burbach-Wahlbach,

: +49 2736 4976 0

: info@hessgroup.com

www.hessgroup.com