

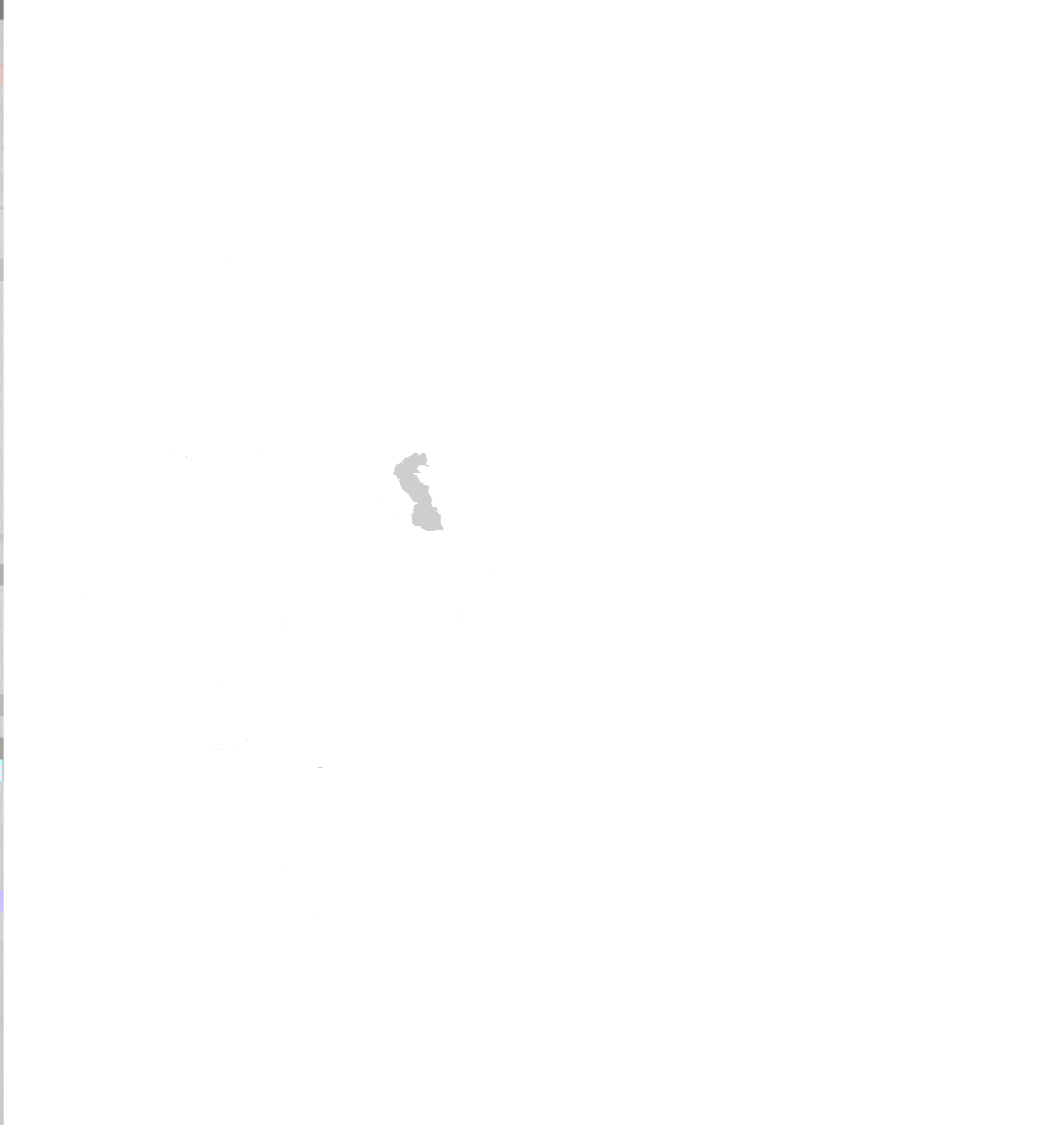

HESS GROUP

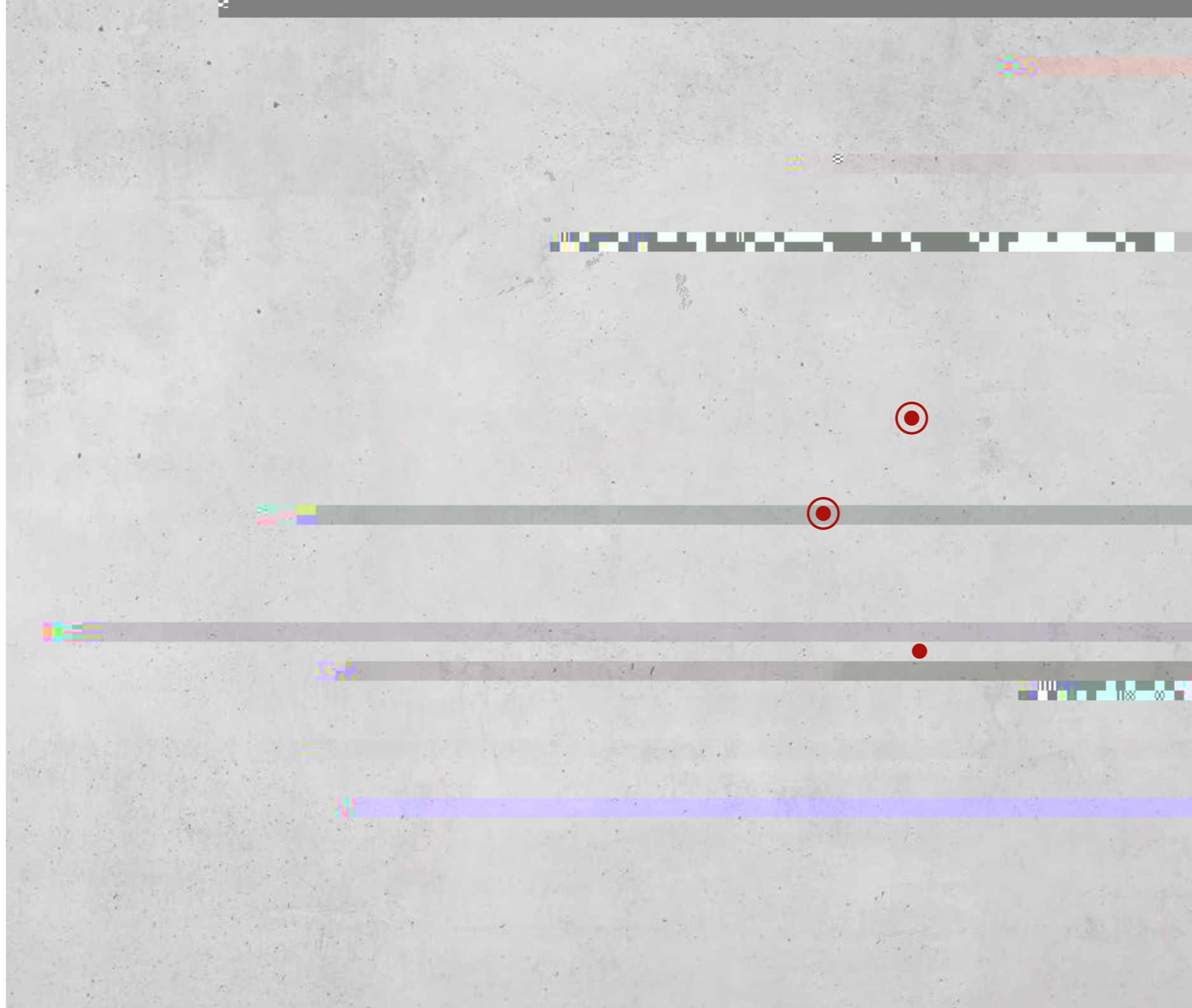



## OUR VISION

It is our endeavor to discover and create new market needs in close collaboration with our customers. For this, we develop solutions that make us and our customers innovative pioneers in the concrete block and paver industry.

Each of our products is developed specifically according to our customers' needs. Our concrete block and paver plants are characterized by their durability and reliability and can be upgraded with the latest technology even after years.

Open and honest communication is essential to us. We work together and develop solutions and results as a team and across departmental boundaries.

## OUR MISSION

We enable our customers – in collaboration with us – to produce the best concrete blocks and pavers efficiently. The following four factors are paramount:

Our customers are at the center of our actions. We are a reliable and honest partner who, together with them, shapes the digital future of our industry.

Each of us has high standards for our personal work results. Taking responsibility for one's own actions and seeing mistakes as opportunities for improvement is part of our culture.

## OUR VALUES

For us, quality means combining durability and reliability with the latest technology.

Innovation involves transforming the market through technology. By continuously enhancing automation, swiftly responding to market needs, and broadening refinement options, we ensure the long-term viability of our products.

In partnership with our customers, we fulfill individual requirements. We support them operationally as a knowledgeable and trustworthy partner.

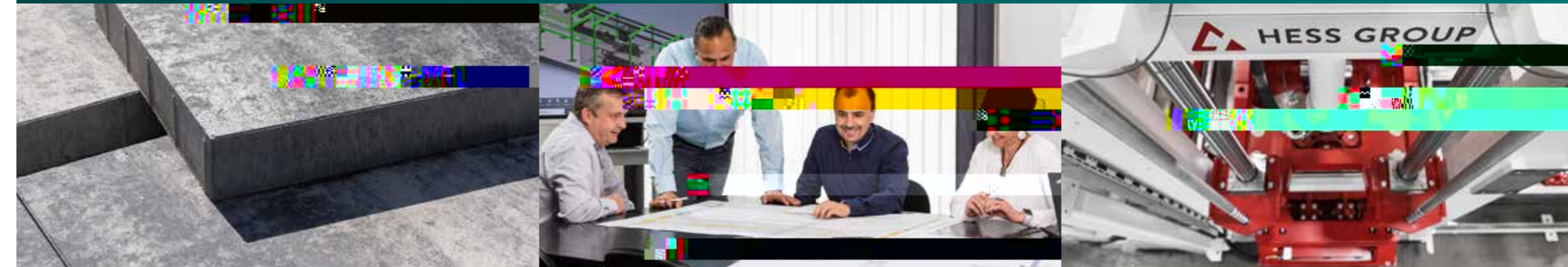

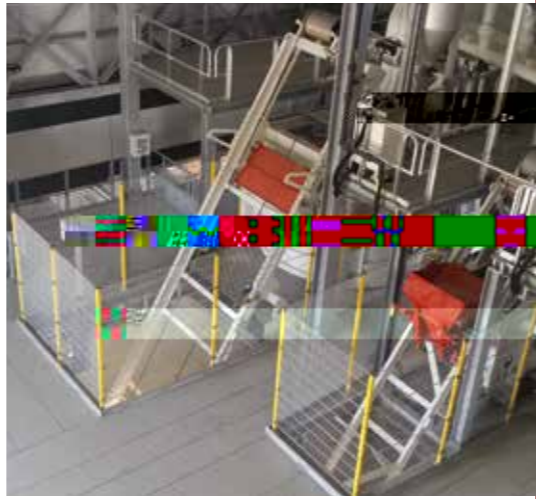
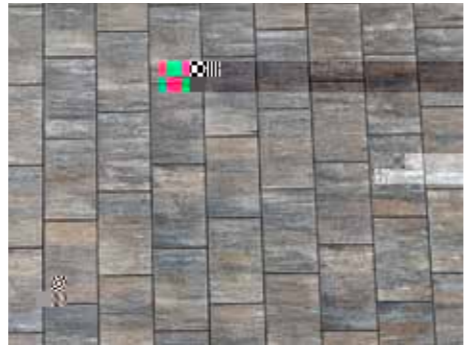

**WE PUT  
CONCRETE  
INTO SHAPE.**

**BATCHING AND  
MIXING PLANTS**





HESS BATCHING AND MIXING PLANTS

**PERFECT MIXING RESULTS IN A SHORT TIME**

We provide the necessary mixing plants for the production of high-quality concrete products, including paving stones, curbstones, hollow blocks, slabs, pipes, manholes, and precast components. Our mixing plants are equipped with all the essential batching devices for aggregates such as cement, water, and additives.

Our SM series concrete mixers are designed to deliver optimal mixing results in minimal cycle time while ensuring easy accessibility. Depending on customer needs and the layout of the plant, we offer a variety of concrete transport systems, including concrete buckets and belt conveyors. Additionally, we provide our premium Color-mix dosing systems for colored concrete products.

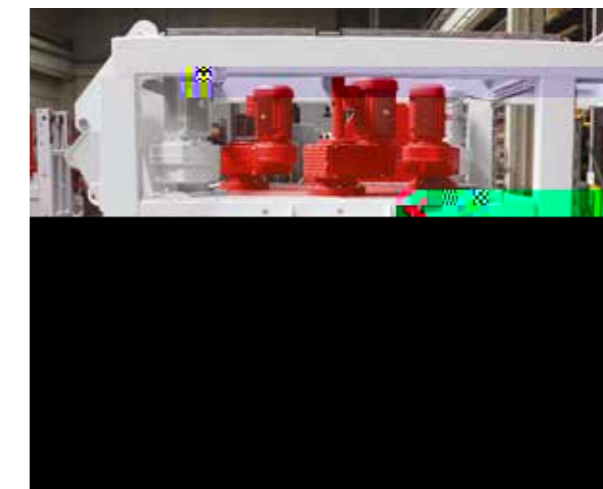
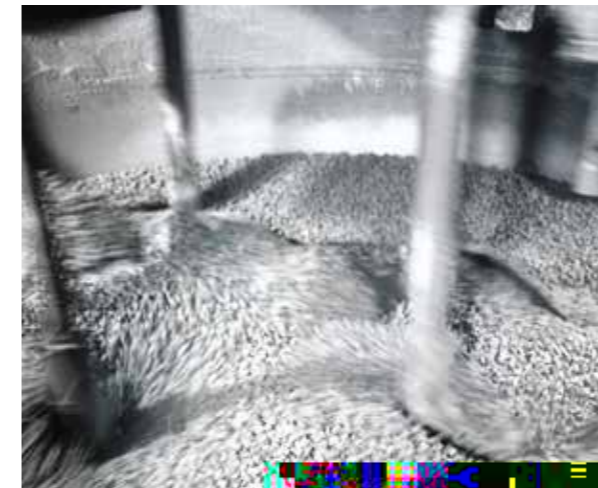

- Self-supporting design with lower and upper frame
- Separate drive system (for tool plate and mixing stars)
- Stopping and re-starting the filled mixer at any time
- Two large opposite doors for optimal cleaning and maintenance
- Two large discharge openings in the bottom
- Significantly less concrete residues and cleaning effort due to special water supply
- Optionally, a special conveying device for cement addition to the mixer is available (almost dust-free cement addition)
- Due to high mixing intensity, particularly suitable for concretes with low water-cement ratio
- Modern microwave moisture measurement
- Ventilation (dust removal) via airbag or external extraction
- High safety through key transfer system



Dry filling [ ]	1,500	2,250	3,375	4,500
Max. filling weight [ kg ]	2,400	3,600	5,400	7,200
Compacted concrete output / batch [ m <sup>3</sup> ]	1	1.5	2.25	3
Main drive [ kW ]	22	30	2 x 22	3 x 22
Number of mixing stars and agitator [ pcs ]	2	2	3	3
Skip hoist drive [ kW ]	18.5	18.5	22	30

Technical changes reserved.

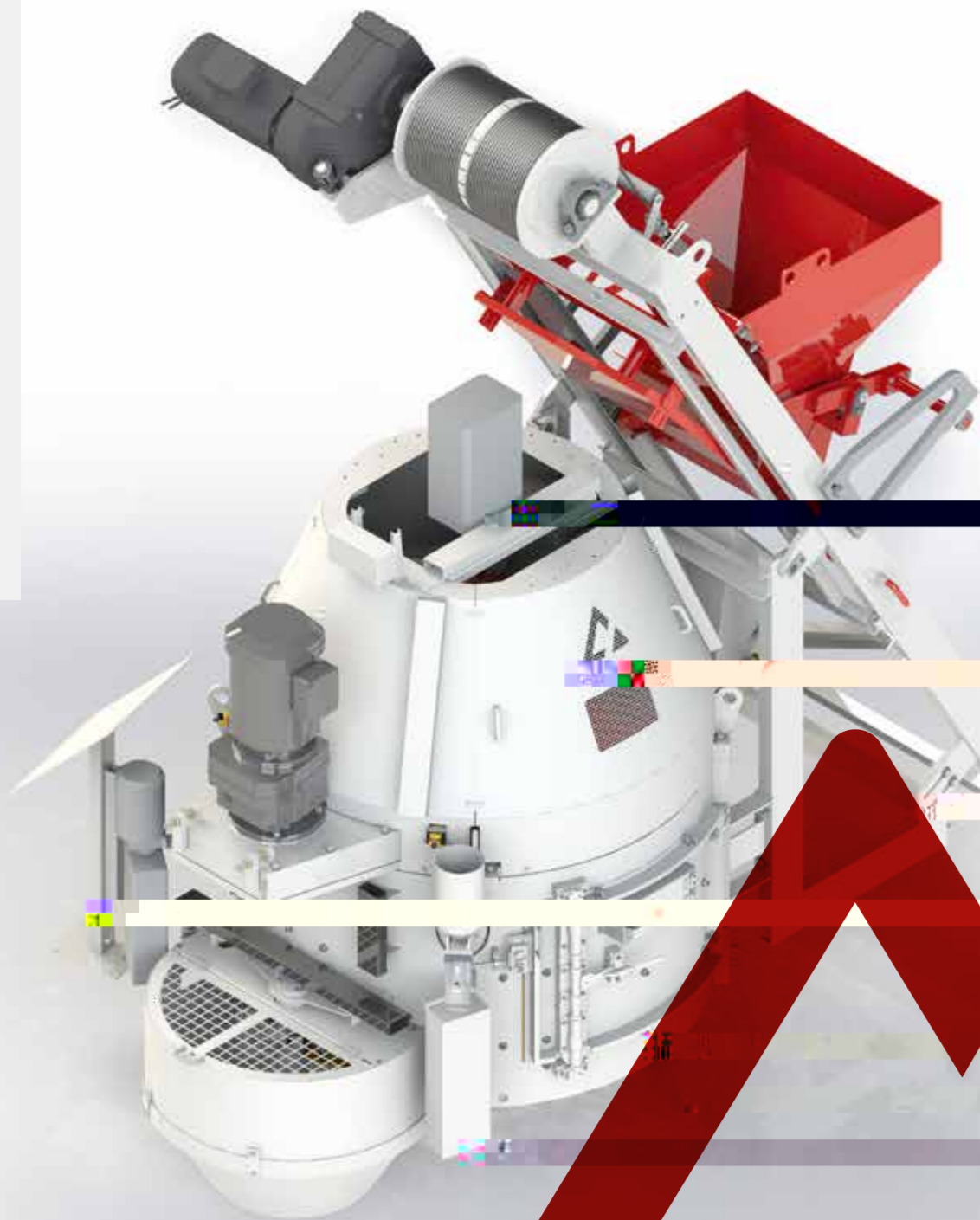

HESS

## FACE CONCRETE MIXER SM 500

The powerful SM 500 is ideal for the production of high-quality face concrete products. Especially in combination with a base concrete mixer of the SM series, individual, high-quality products with a solid base and finest face mix layer can be produced.



Dry filling [ l ]	500
Max. filling weight [ kg ]	800
Compacted concrete output / batch [ m <sup>3</sup> ]	0.333
Main drive [ kW ]	15
Number of mixing stars and agitator [ pcs ]	1+1
Skip hoist drive [ kW ]	7.5

Technical changes reserved.

- Sturdy base frame
- Two large doors with robust lock for good accessibility
- Optimized arrangement of mixing tools
- Optimized Pan diameter
- Tools
  - Mixing star with PU shovel, optional with cast steel shovel
  - Powerful agitator with wear-resistant rods
  - Side & bottom scrapers
- Hydraulically driven segment slide plate as concrete outlet
- Water supply from below for optimal distribution (optional from above)
- Optimal mixing results at all filling levels
- Minimum filling quantity of 160 l
- Optional high-pressure cleaning
- Stopping and re-starting the filled mixer at any time



### 3 COLORMIX SYSTEMS

#### ADVANCED

Installing a draw plate with a silo extension on the concrete block and paver machine silo allows for efficient production of Colormix products. The mixing plant supplies concrete in various colors onto the draw plate. The draw plate opens in adjustable sequences, enabling the differently colored concrete to flow into the machine hopper. This solution is suitable for both the face and base mix hopper.

#### PROFESSIONAL

Three concrete hoppers are placed side by side, each containing differently colored concrete. Each hopper is equipped with a discharge belt that regulates the position of the concrete as it is released onto the collection belt. The frequency-controlled collecting belt to the face mix silo of the concrete block machine can be moved left and right by an electric motor to distribute the concrete evenly into the machine hopper. Since all belt drives are speed-controlled, the color gradient in the final product can be accurately reproduced. Additionally, all parameters can be stored in the corresponding recipes.

#### ULTIMATE

The premium solution for producing multicolored concrete products involves a setup with up to four concrete hoppers. These hoppers are filled using a flying bucket that has the same number of buckets, which helps prevent contamination of colors before dosing. The discharge belts are both movable and speed-controlled. Additionally, the collection belt is also movable and speed-controlled, ensuring a controlled distribution of multicolored concrete into the hopper. This setup guarantees the reproducibility of defined color gradients in the final product. All parameters can be stored based on specific recipes. A similar system is also available for base concrete.



HESS

## BATCHING AND MIXING PLANT CONTROL

CONTROL OVER ALL FUNCTIONS



With just one glance, the entire process of the mixing plant is captured. This enables quick and efficient monitoring and control.

Components are controlled with as few mouse clicks as possible. This reduces the effort for the operator and increases productivity.

The design is clear and easy to understand. An intuitive user interface makes it easier to control the batching and mixing plant.

Our moisture measurement and water dosing are characterized by intuitive handling and precise function. The entire effort for process-safe handling of concrete recipes has been reduced to a minimum.

The diagnostic function supports quick troubleshooting and minimizes downtime. Context-related tooltips or pop-up messages help with this.

The software features a shift management system. Complete shift processes are logged, and all production-relevant data of the manufacturing process are collected and stored.

The additional function of comparable recipe data extends your plant visualization, allowing you to compare the current parameters of the batching and mixing plant with previously stored recipes.

All relevant data points of the mixing process are collected, stored, and available for evaluation. An optional connection to the ERP system of the customer is available. All material consumption data from the mixing plant can thus be managed by the customer.

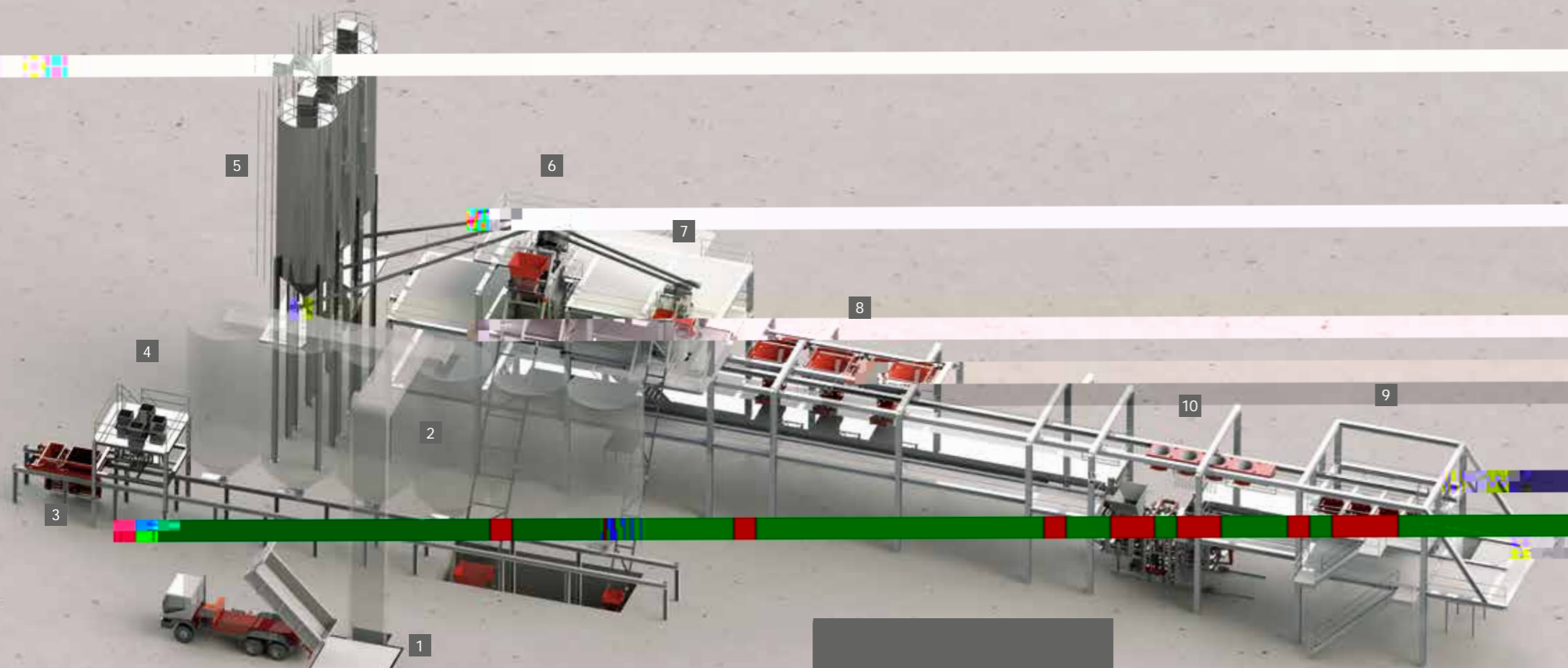

- |   |                         |    |                                       |
|---|-------------------------|----|---------------------------------------|
| 1 | Truck dump hopper       | 6  | Base concrete mixer                   |
| 2 | Aggregate silo          | 7  | Face concrete mixer                   |
| 3 | Aggregate weigh-batcher | 8  | Colormix dosing station base concrete |
| 4 | Pigment dosing station  | 9  | Colormix dosing station face concrete |
| 5 | Cement silos            | 10 | Flying Bucket system face concrete    |

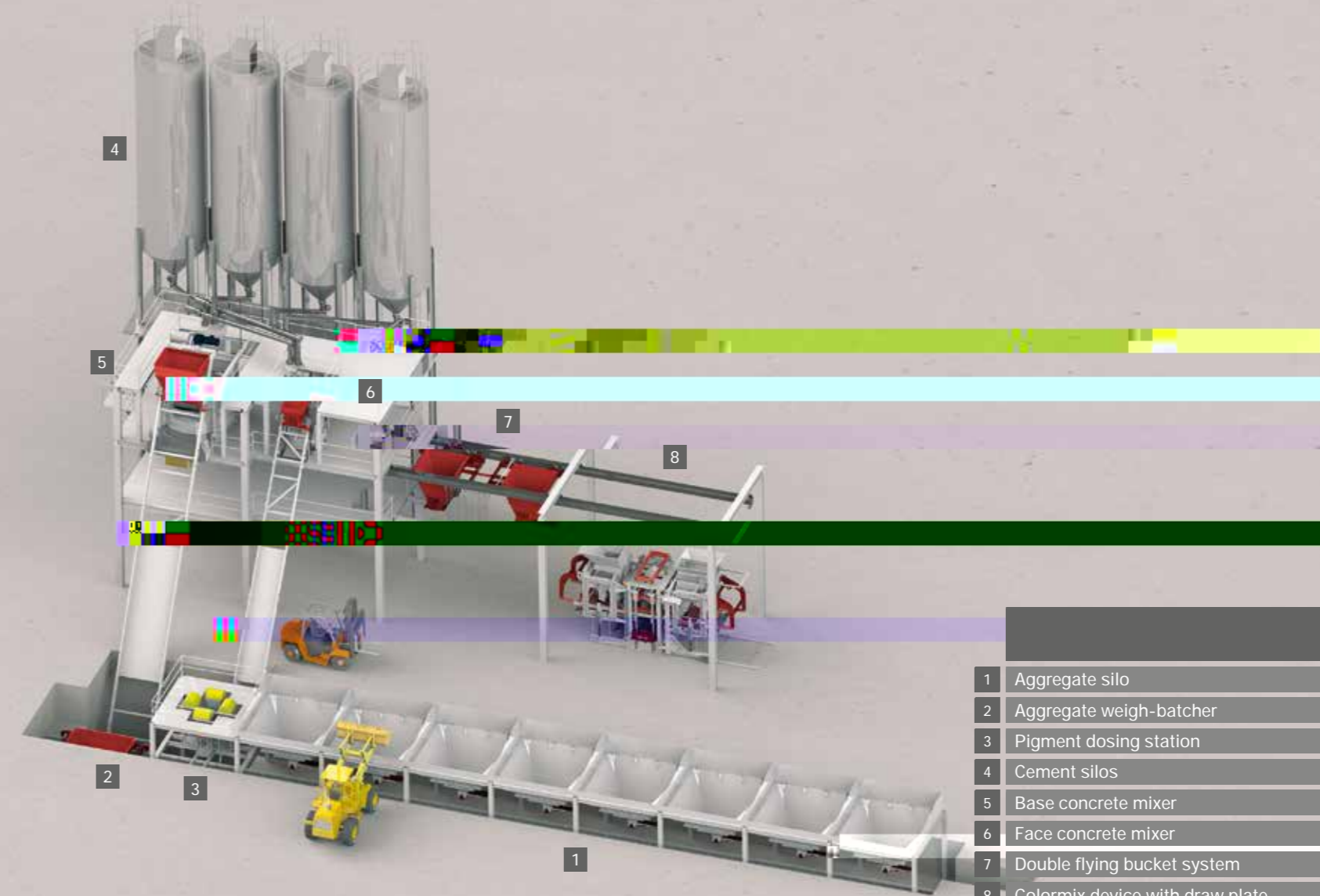

- |   |                                 |
|---|---------------------------------|
| 1 | Aggregate silo                  |
| 2 | Aggregate weigh-batcher         |
| 3 | Pigment dosing station          |
| 4 | Cement silos                    |
| 5 | Base concrete mixer             |
| 6 | Face concrete mixer             |
| 7 | Double flying bucket system     |
| 8 | Colormix device with draw plate |



